







25 023 360



- sporgenza 160 mm
- Doccetta: COMPACT RAIN, portata max. 9 l/min (a 3 bar)
- Bocca: getto normale squadrato
- supporto doccetta
- Deviatore a rotazione vasca/doccia
- rosetta Ø 70 mm
- ingresso 1/2"
- interasse 153 mm
- Flessibile doccetta in metallo 1250mm con protezione antitorsione integrata
- portata max bocca 26 l/min

Sistema di sicurezza antiriflusso.

	Cromato	25 023 360-00
	Platinato spazzolato	25 023 360-06
	Platinato	25 023 360-08
	Ottone (Oro 23k)	25 023 360-09
	Ottone spazzolato (Oro 23k)	25 023 360-28
	Dark Platinum spazzolato	25 023 360-99

25 023 360

mm [inches]



Diagramma di portata



Certificati

WRAS_1512014. Belgaqua_21-378-27_2.

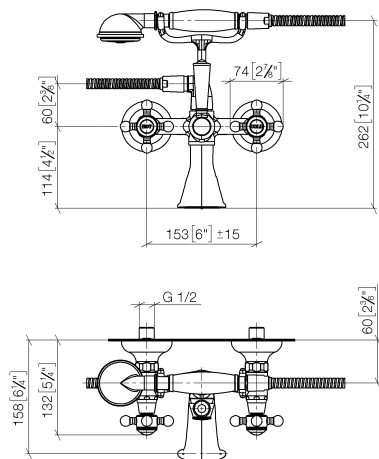
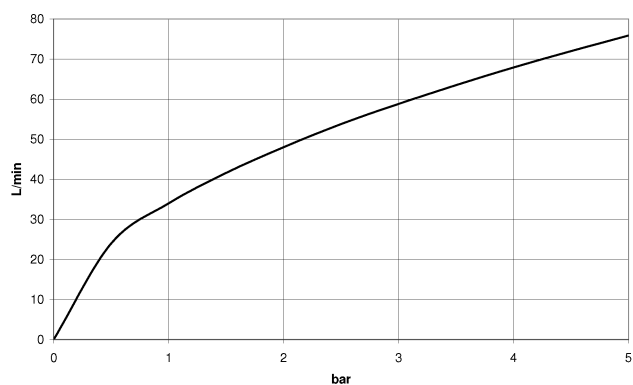
25 023 360

Parts for other
finishes can be found
here: [Platinato](#)
[spazzolato](#)

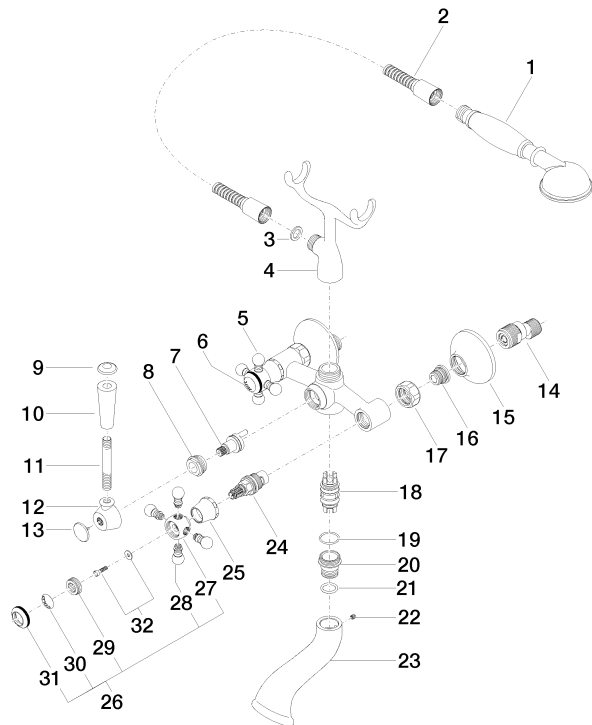

25 023 360

Elenco delle parti di ricambio

N.	Codice articolo	Denominazione	Quantità necessaria	Tempo di produzione
1	28 002 970-00	MADISON Doccetta in metallo con manico in porcellana - Cromato	1	10
2	28 104 970-00	Flessibile metallico per doccetta 1/2" x 1/2" x 1250 mm - Cromato	1	2
3	90 14 20 002 00 90	guarnizione	1	2
4	04 17 20 010 00-00	sostegno	1	10
5	04 20 36 002 07-00	manopola (hot)	1	10
6	09 26 01 011 90	accessori	1	2
7	90 15 01 001 00 90	deviatore	1	2
8	09 23 10 007 90	dado	1	2
9	09 30 30 062-00	vite	1	10
10	11 170 370-00	MADISON Impugnatura leva - Cromato	1	10
11	09 28 22 013 90	tubo	1	2
12	09 18 20 011-00	alloggio	1	10
13	09 30 30 064-00	vite	1	10
14	04 11 04 030 00 90	attacco	2	2
15	09 27 39 010-00	rosetta	2	10
16	04 29 05 014 00 90	ugello	2	2
17	09 23 30 010-00	dado	2	10
18	90 21 10 010 00 90	inserto	1	2
19	90 14 10 056 00 90	guarnizione	1	2
20	09 24 03 123 20 90	ugello	1	2
21	09 14 10 022 90	guarnizione	1	2
22	90 31 11 030 00 90	perno	1	2
23	09 11 06 033 20-00	bocca di erogazione	1	10
24	90 90 03 131 00 90	parte superiore	2	2
25	09 21 02 055-00	copertura	2	10
26	04 20 36 002 06-00	manopola (cold)	1	10
27	09 20 36 002-00	manopola	2	10
28	09 20 36 004-00	manopola	8	10
29	09 20 83 006 90	manopola	2	2
30	09 26 01 010 90	accessori	1	2
31	09 20 36 005-00	manopola	2	10
32	04 30 30 029 00 90	set di fissaggio	2	2